

Service Manual

Stereo Graphic Equalizer

40629 SH-GE70

Equalizer

Color

(K) Black Type

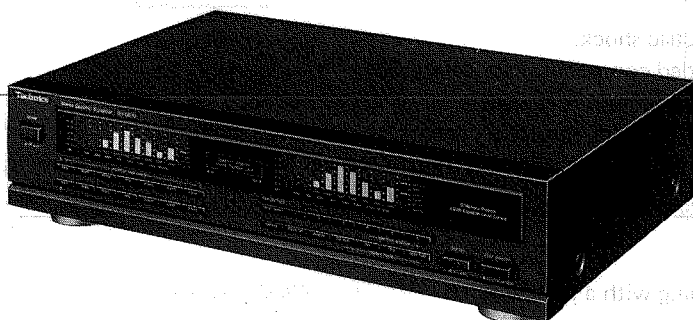

Areas

Country Code	Areas	Color
(PP)	U.S.A./Canada	(K)
(E)	Continental Europe	
(EB)	Great Britain	
(EG)	F.R. Germany/Italy	
(GC)	Asia, Latin America, Middle Near East and Africa	
(GN)	Oceania	

SPECIFICATIONS (DIN 45 500)

Frequency response

- (centre position) : 5 Hz~100 kHz (-3 dB)
- Maximum output voltage : 8 V (1 kHz, THD 0.03%)
- Rated output voltage : 1 V
- Maximum input voltage : 8 V (1 kHz)
- Input sensitivity : 1 V
- Rated total harmonic distortion : 0.005% (20 Hz~20 kHz), at 1 V output
- 0.003% (1 kHz), at 1 V output
- Signal-to-noise ratio : 105 dB/1 V, IHF 'A'
- Input impedance : 47 kΩ
- Gain : 0±1 dB
- Equalization-level controls : +12 dB~-12 dB
(7 frequency ranges, in 2 dB steps)
- Centre frequencies : 63 Hz, 160 Hz, 400 Hz, 1 kHz, 2.5 kHz, 6.3 kHz, 12.5 kHz

GENERAL

Power supply

- For U.S.A. and Canada : AC 60 Hz, 120 V
- For Continental Europe, F.R. Germany and Italy : AC 50 Hz/60 Hz, 220 V
- For Great Britain and Oceania : AC 50 Hz/60 Hz, 240 V
- For Others : AC 50 Hz/60 Hz, 110 V/127 V/220 V/240 V

Power consumption

- 11 W
(with power switch off: 6.5 W)

Dimensions (W×H×D)

- 430×102×280 mm
(16¹⁵/₁₆"×4¹/₃₂"×11¹/₃₂"

Weight

- 2.9 kg (6.4 lb)

Notes:

1. Specifications are subject to change without notice.
2. Weight and dimensions are approximate.
3. Total harmonic distortion is measured by the digital spectrum analyzer.

Technics

Matsushita Services Company
Division of Matsushita Electric
Corporation of America
50 Meadowland Parkway,
Secaucus, New Jersey 07094

Panasonic Sales Company,
Division of Matsushita Electric
of Puerto Rico, Inc.
San Gabriel Industrial Park
65th Infantry Ave. Km.9.5
Carolina, P.R. 00630

Matsushita Electric of Canada Limited
5770 Ambler Drive, Mississauga, Ontario,
L4W 2T3

Matsushita Electric Industrial
Co., Ltd.
Central P.O. Box 288,
Osaka 530-91, Japan

CONTENTS

	Page		Page
SAFETY PRECAUTION	2	TERMINAL GUIDE OF IC'S, TRANSISTORS AND DIODES	13
ACCESSORIES	2	WIRING CONNECTION DIAGRAM	14
LOCATION OF CONTROLS	3, 4	PRINTED CIRCUIT BOARDS	15-17
CONNECTIONS	5	DESCRIPTION OF FL PANEL	18
DISASSEMBLY INSTRUCTIONS	6	FUNCTIONS OF IC TERMINALS	19
BLOCK DIAGRAM	7, 8	REPLACEMENT PARTS LIST	20-22
SCHEMATIC DIAGRAM	9-13	EXPLODED VIEW	23

SAFETY PRECAUTION (This "safety precaution" is applied only in U.S.A.)

1. Before servicing, unplug the power cord to prevent an electric shock.
2. When replacing parts, use only manufacturer's recommended components for safety.
3. Check the condition of the power cord. Replace if wear or damage is evident.
4. After servicing, be sure to restore the lead dress, insulation barriers, insulation papers, shields, etc.
5. Before returning the serviced equipment to the customer, be sure to make the following insulation resistance test to prevent the customer from being exposed to a shock hazard.

INSULATION RESISTANCE TEST

1. Unplug the power cord and short the two prongs of the plug with a jumper wire.
2. Turn on the power switch.
3. Measure the resistance value with ohmmeter between the jumpered AC plug and each exposed metal cabinet part, such as screwheads, antenna, control shafts, handle brackets, etc. Equipment with antenna terminals should read between $3M\Omega$ and $5.2M\Omega$ to all exposed parts. (Fig. A) Equipment without antenna terminals should read approximately infinity to all exposed parts. (Fig. B)

Note: Some exposed parts may be isolated from the chassis by design. These will read infinity.

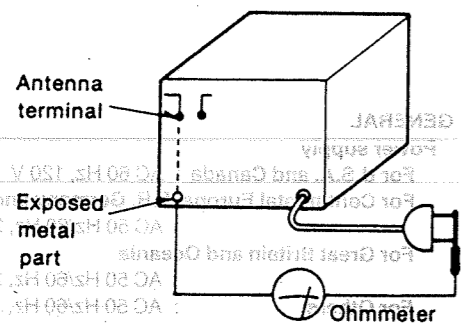

(Fig. A)

Resistance = $3M\Omega$ — $5.2M\Omega$

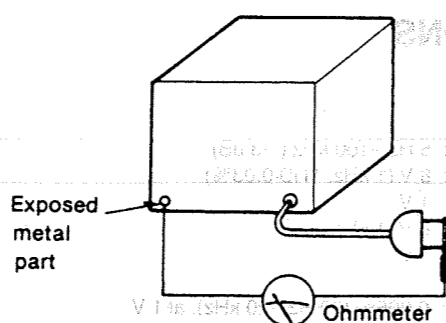

(Fig. B)

Resistance = Approx. ∞

4. If the measurement is outside the specified limits, there is a possibility of a shock hazard. The equipment should be repaired and rechecked before it is returned to the customer.

ACCESSORIES

- | | | | |
|------------------------|-------------------------|---------------------------|---------------------|
| • AC power supply cord | 1 | • Stereo connection cable | 2 |
| (SJA175) | For [PP] area only. | (SJP2249-3) | |
| (SFDAC05E03) | For [E] and [EG] areas. | | |
| (SJA193) | For [EB] area only. | • Attachment plug | 1 |
| (RJA0004) | For [GC] area only. | (SJP9215) | For [GC] area only. |
| (SJA173) | For [GN] area only. | | |

LOCATION OF CONTROLS

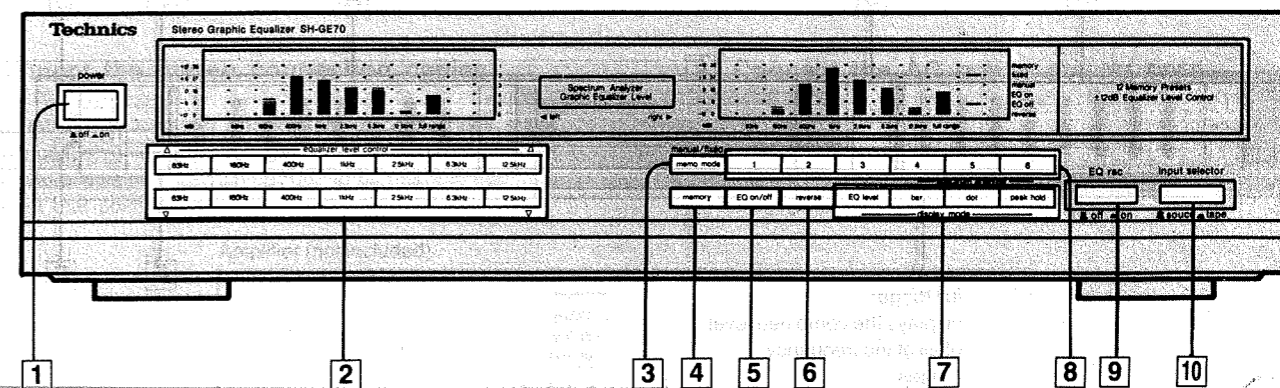

Control section

1 Power switch (power off on)

"Power-through" function

Discs, radio broadcasts, etc. can be heard even if the power of this unit is switched OFF.
Note, however, that the power plug should be left connected to the AC outlet.

2 Equalizer level-control buttons (equalizer level control)

These buttons are used for adjustment of the equalization level of the left channel and right channel simultaneously.
Upper row: These buttons are used to increase the level of each sound range (frequency range).
Lower row: These buttons are used to reduce the level of each sound range (frequency range).

3 Memory mode-select button (memo mode)

This button is used to select the equalization memory mode to be used.

manual: Select this mode to program a desired curve to the unit's memory or to retrieve a curve that you have programmed.

fixed: Select this mode to retrieve a curve that was originally pre-programmed to the unit's memory.

4 Memory button (memory)

This button is used to program the equalization curve into the memory.

5 Equalization mode-select button (EQ on/off)

This button is used to switch the equalization correction function "EQ on" and "off". Each time a button is pressed, the mode changes alternately to one or the other of the following modes.

EQ on: Select this mode to make an equalization correction.

EQ off: Select this mode if no equalization correction is desired.

Note that the "EQ on" mode is automatically selected if a preset-memory button or an equalizer level-control button is pressed while this button is set to the "EQ off" mode.

6 Reverse button (reverse)

This button is used to reverse the equalization curve shown in the display.

7 Display mode-select buttons (display mode)

These buttons are used to select the equalization-level display mode and any of the three types of spectrum display mode described below.

Equalization-level display mode

EQ level: Select this mode when you want to display the equalization level.

Spectrum display modes (spectrum analyzer)

bar: Select this mode when you want a bar-type display.

dot: Select this mode when you want a dot-type display.

peak hold: Select this mode when you want the peak to be held in the display.

8 Preset-memory buttons (1-6)

These buttons are used to program an equalization curve into the memory, or to retrieve a curve originally programmed into the unit's memory.

9 Recording mode selector (EQ rec off on)

on: Set to this position to make a tape recording of the source while controlling the frequency response.

off: Set to this position to record without equalizer correction.

10 Input selector (source tape)

source: Set to this position to listen to the radio or a compact disc, etc.

tape: Set to this position to listen to a tape deck connected to the back of this unit.

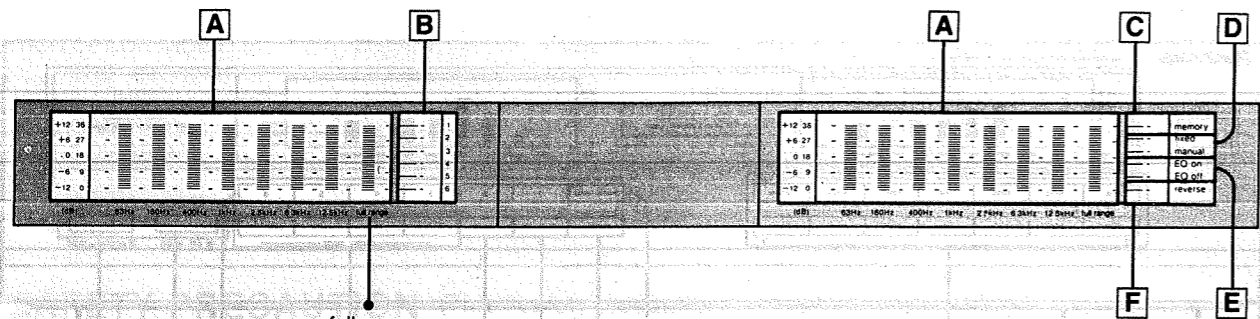

full range displays the combined level of all of the frequency ranges.

Display section

A Equalization/Spectrum display

The following equalization-level display and three types of spectrum display are possible.

Equalization-level display

The amount of correction is displayed by a series of lines (=) for each sound range. (frequency range).

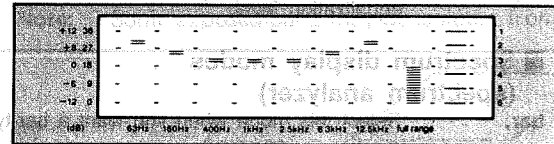

Spectrum displays

Bar-type display

This display can be used to show the output strength for each sound range (frequency range), and to show the output strength of sound for all ranges (full range) by a bar-type display.

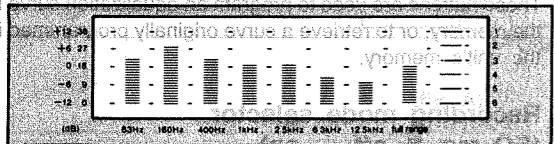

Dot display

Only the upper two parts of the bar display are shown, thus making the strength of the sound for each sound range even easier to see.



Peak-hold display

The peak sound value of each sound range is held on the display for about two seconds after it occurs.

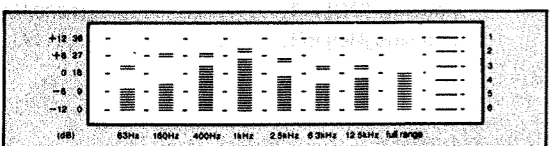

Note:

If an equalization level-control or the memory-mode selector or a preset-memory button is pressed during any display other than the equalization-level display, the equalization-level display will be shown for about five seconds, after which the former display will return.

B Equalization-preset indicators (1-6)

The indicator corresponding to the pressed preset-memory button will illuminate.

manual: Indicates an equalization curve that you programmed into the memory.

fixed: Indicates one of the six equalization curves that were originally programmed into the memory.

C Equalization-memory indicator (memory)

This indicator illuminates when the memory button is pressed, thus indicating that an equalization curve can be programmed into the memory.

D Memory-mode indicators

fixed: Indicates that one of the equalization curves that were originally programmed into the memory can be retrieved.

manual: Indicates that an equalization curve that you programmed into the memory can be retrieved.

E Equalization-mode indicators

EQ on: Indicates that the equalization effect has been switched ON.

EQ off: Indicates that the equalization effect has been switched OFF.

F Reverse indicator (reverse)

This indicator illuminates when the reverse button is pressed, thus indicating that an equalization curve is reversed. Note, however, that there will be no illumination if the equalization curve is flat.

CONNECTIONS

Make connections in the numbered sequence by using the included cables.

1 Connect the stereo connection cables.

2 Connect the AC power supply cord.

The illustration below shows an example of connections made when this unit is combined with a Technics electronic component system, and shows only the connections to be made to and from this unit in that combination.

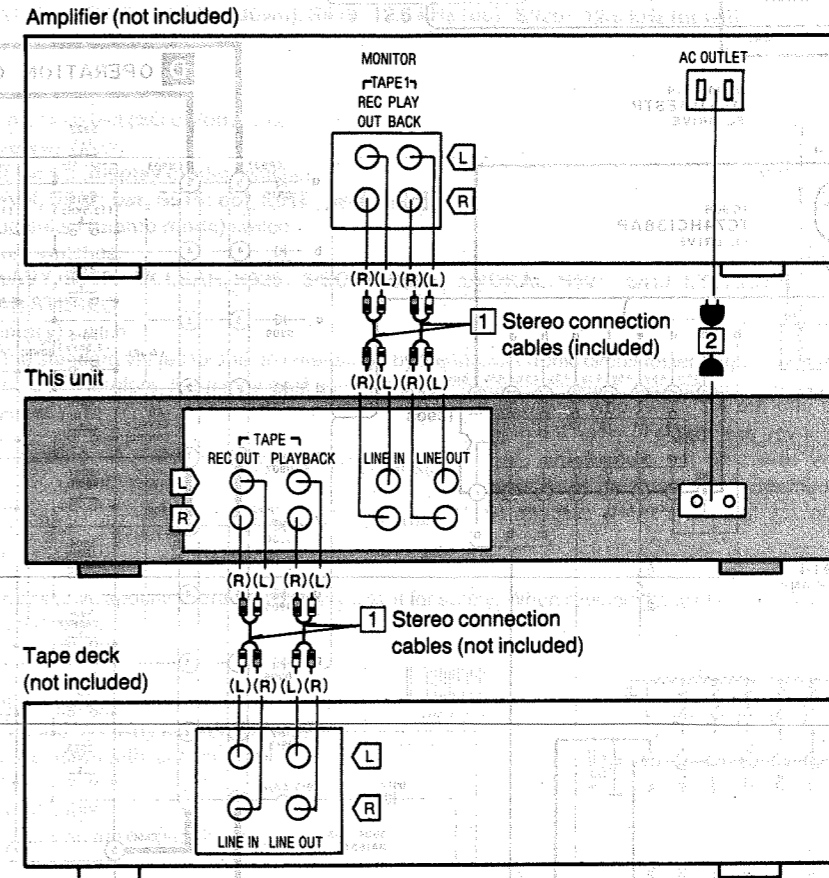

DISASSEMBLY INSTRUCTIONS

"ATTENTION SERVICER"

Some chassis components may have sharp edges. Be careful when disassembling and servicing.

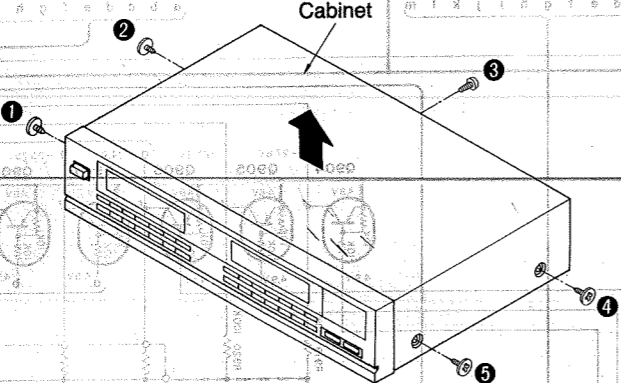
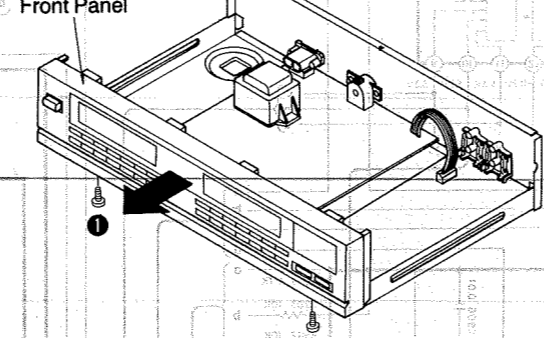
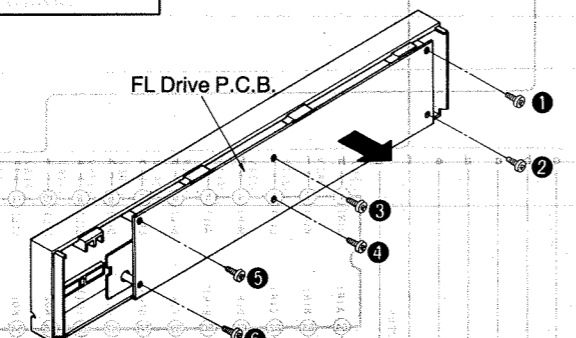
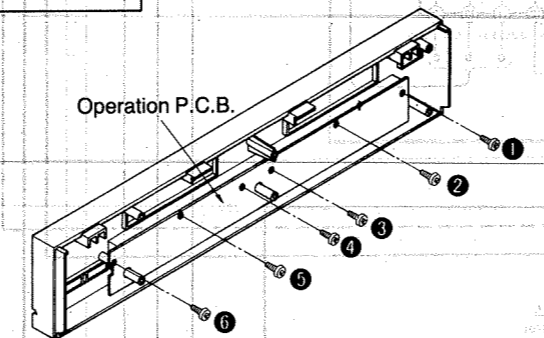
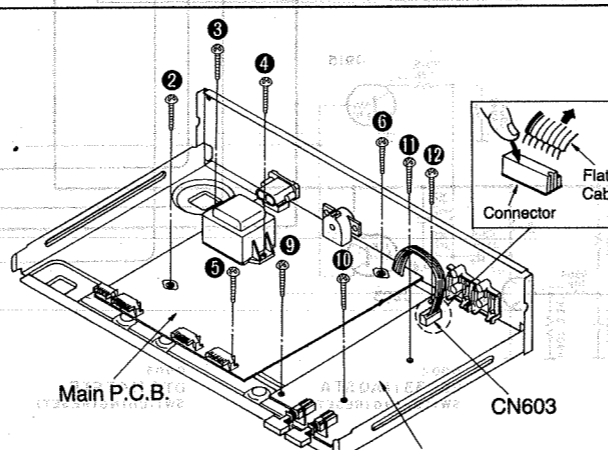
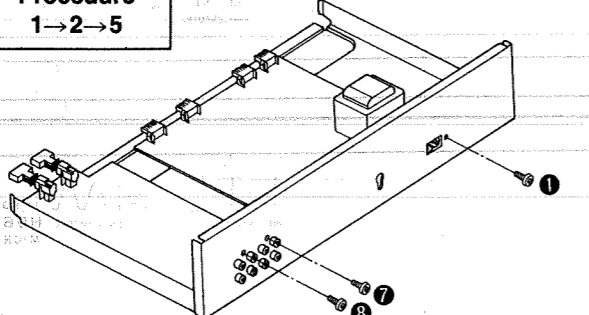
Ref. No. 1	Removal of the Cabinet	Ref. No. 2	Removal of the Front Panel
Procedure 1		Procedure 1→2	
<p>● Remove the 5 screws (1~5).</p>		<p>1. Remove the 2 screws (1, 2). 2. Remove the front panel in the direction of the arrow.</p>	
Ref. No. 3	Removal of the FL Drive P.C.B.	Ref. No. 4	Removal of the Operation P.C.B.
Procedure 1→2→3		Procedure 1→2→3→4	
<p>1. Remove the 6 screws (1~6). 2. Remove the FL drive P.C.B. in the direction of the arrow.</p>		<p>● Remove the 6 screws (1~6).</p>	
Ref. No. 5	Removal of the Main P.C.B. and Switch P.C.B.		
Procedure 1→2→5		<p>■ Main P.C.B. 1. Remove the 6 screws (1~6). 2. Remove the 1 flat cable (CN603).</p> <p>■ Switch P.C.B. 1. Remove the 6 screws (7~12). 2. Remove the 1 flat cable (CN603).</p>	

BLOCK DIAGRAM

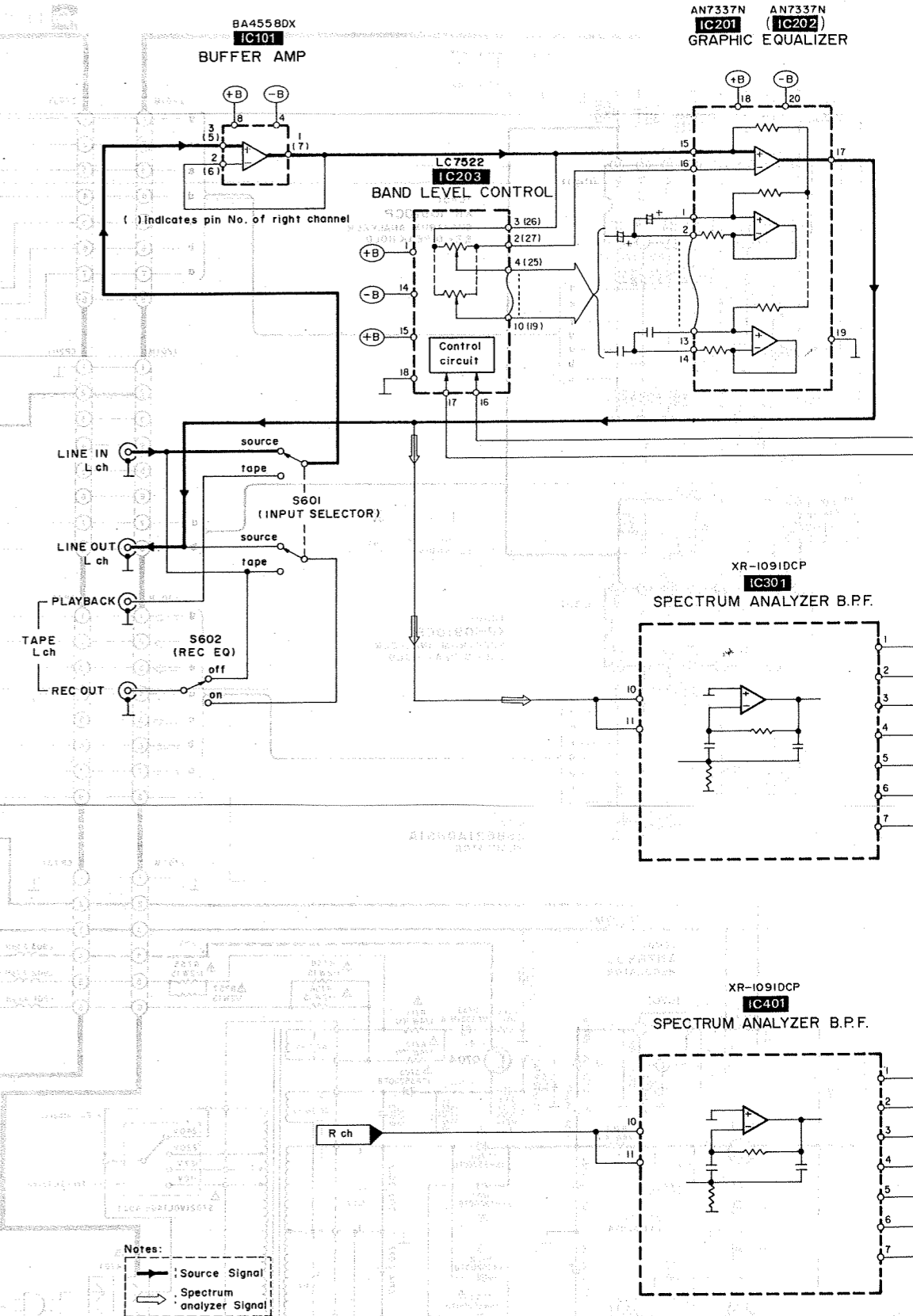

BLOCK DIAGRAM

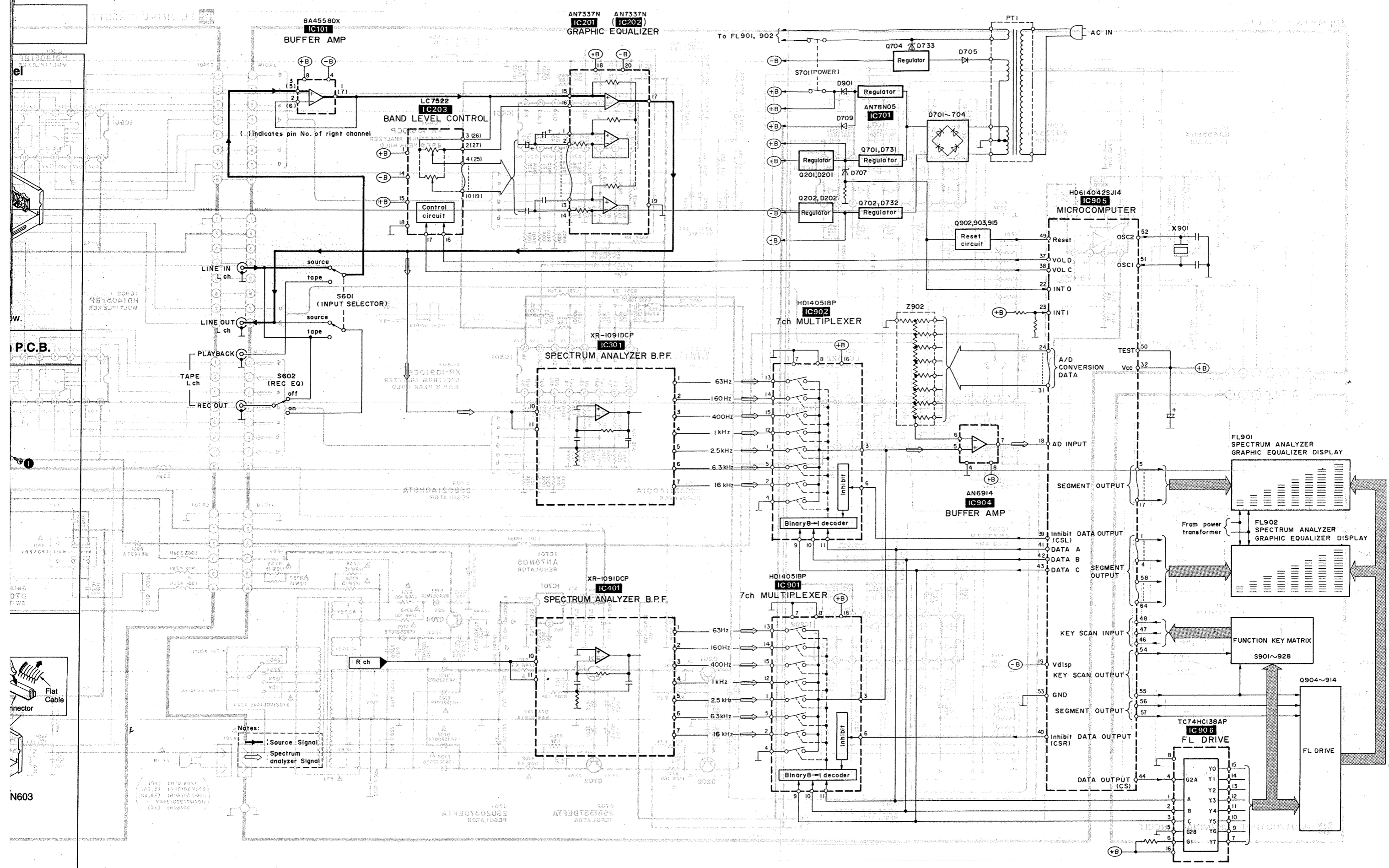

Notes:
 → Source Signal
 → Spectrum analyzer Signal

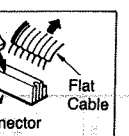

N603

DRIVE CIRCUIT

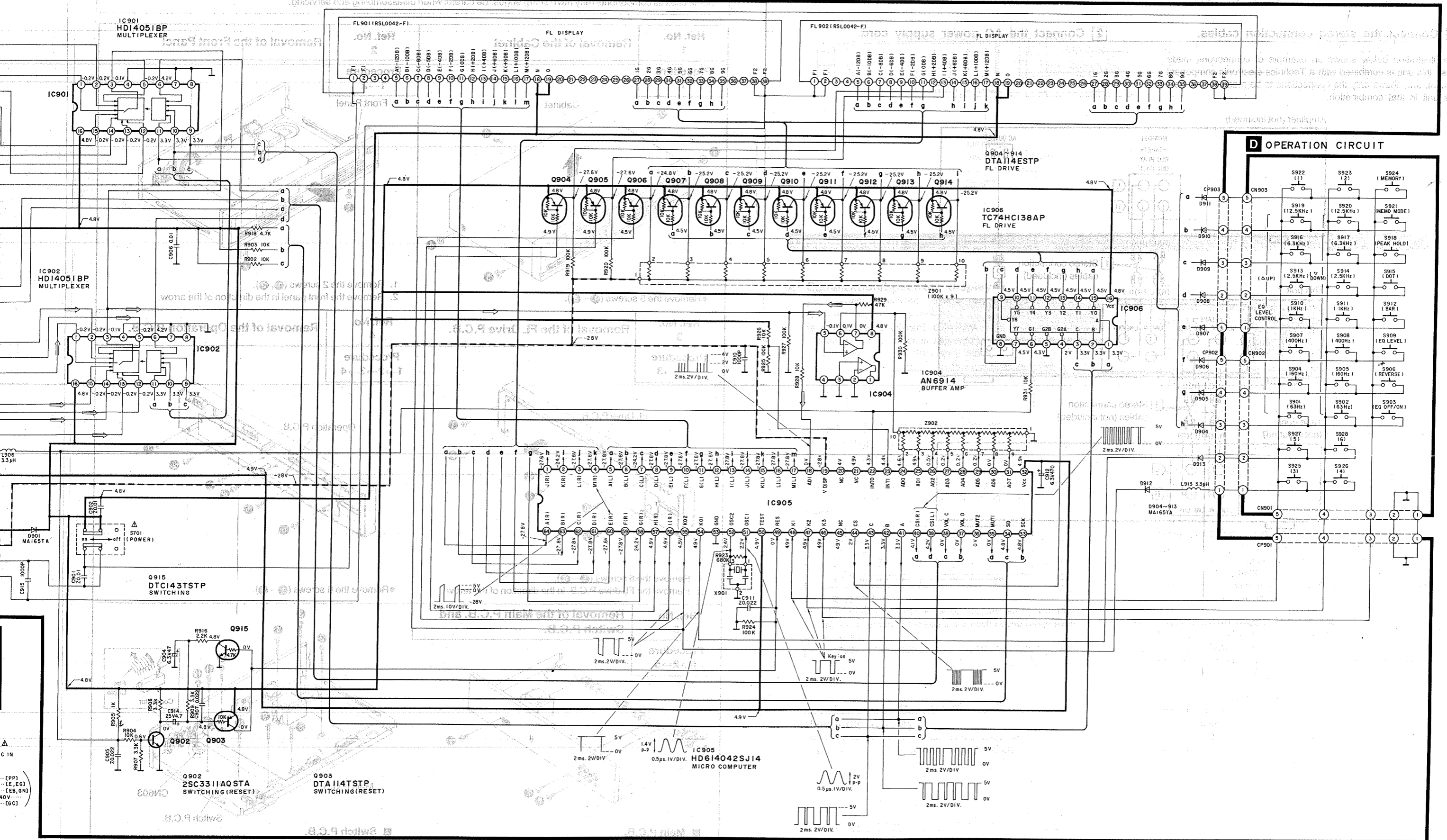

C FL DRIVE CIRCUIT

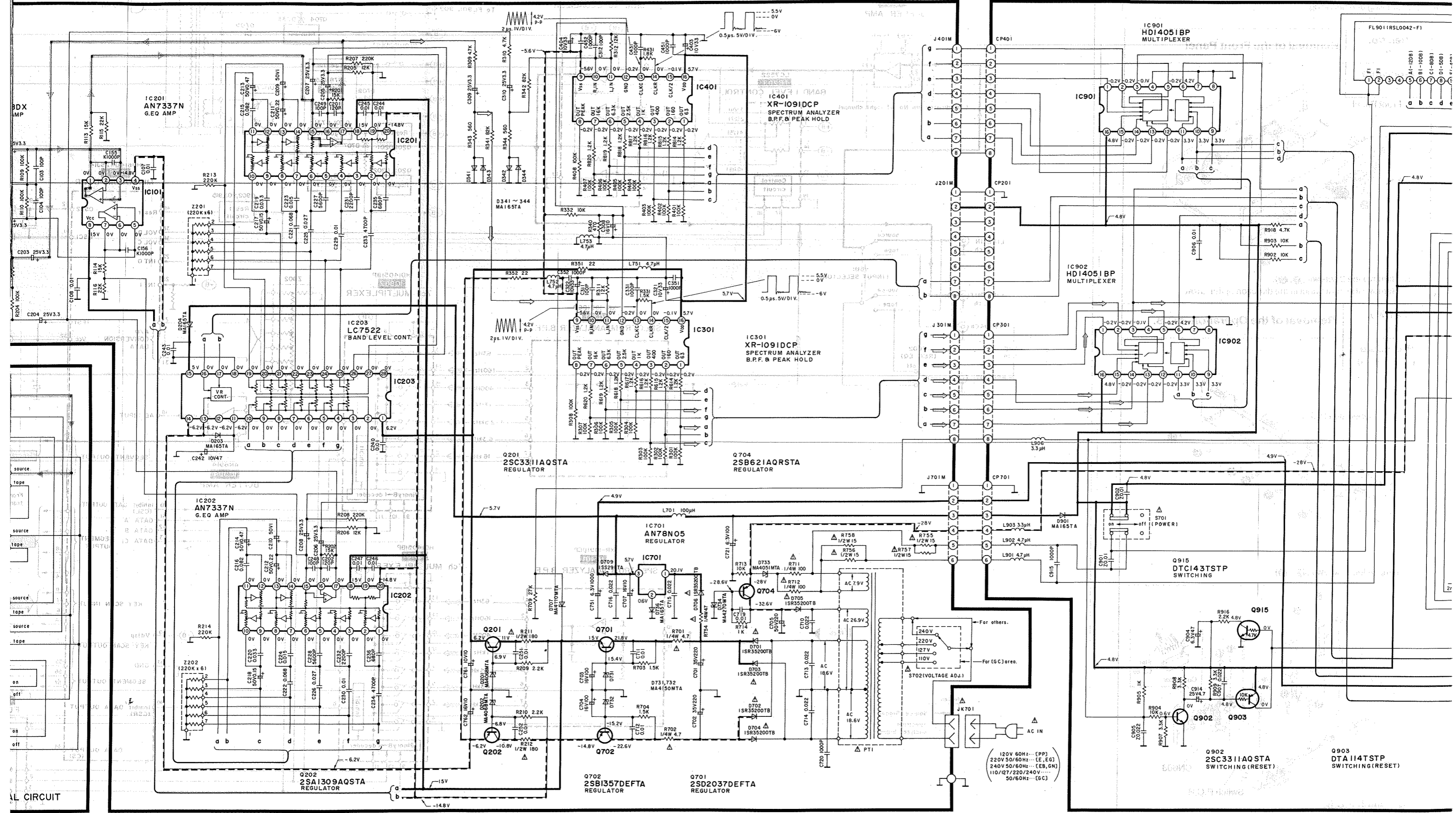

SCHEMATIC DIAGRAM (Parts list on pages 20~22.)

(This schematic diagram may be modified at any time with the development of new technology.)

Notes:

- S601 : Input selector (**input selector**) switch in "source" position.
 - S602 : Recording mode selector (**EQ rec**) switch in "off" position.
 - S701 : Power switch in "on" position.
 - S702 : Voltage selector switch in "240 V" position.
[110 V/127 V/220 V/240 V]
For [GC] area only.
 - S901, S902 : Equalizer level control switches.
S904, S905 [S901: 63 Hz (up), S902: 63 Hz (down), S904: 160 Hz (up), S905: 160 Hz (down), S907: 400 Hz (up),
S907, S908 S908: 400 Hz (down), S910: 1 kHz (up), S911: 1 kHz (down), S913: 2.5 kHz (up), S914: 2.5 kHz (down),
S910, S911 S916: 6.3 kHz (up), S917: 6.3 kHz (down), S919: 12.5 kHz (up), S920: 12.5 kHz (down)]
S913, S914
S916, S917
S919, S920
 - S903 : Equalization mode-select (**EQ on/off**) switch.
 - S906 : Reverse (**reverse**) switch.
 - S909, S912 : Display mode-select (**display mode**) switches.
S915, S918 [S909: EQ level, S912: bar, S915: dot, S918: peak hold]
 - S921 : Memory mode-select (**memo mode**) switch.
 - S922, S923 : Preset-memory switches.
S925~S928 [S922: 1/HEAVY, S923: 2/CLEAR, S925: 3/SOFT, S926: 4/VOKAL, S927: 5/H.P STEREO,]
S928: 6/CAR STEREO
 - S924 : Memory (**memory**) switch.
- Indicated voltage values are the standard values for the unit measured by the DC electronic circuit tester (high-impedance) with the chassis taken as standard. Therefore, there may exist some errors in the voltage values, depending on the internal impedance of the DC circuit tester.



Important safety notice:

Components identified by Δ mark have special characteristics important for safety. When replacing any of these components, use only manufacturer's specified parts.

Caution!

- IC and LSI are sensitive to static electricity.
- Secondary trouble can be prevented by taking care during repair.
- Cover the parts boxes made of plastics with aluminum foil.
- Ground the soldering iron.
- Put a conductive mat on the work table.
- Do not touch the legs of IC or LSI with the fingers directly.

TERMINAL GUIDE OF IC'S, TRANSISTORS AND DIODES

<p>AN6914 BA4558DX</p>	<p>XR-1091DCP</p>	<p>HD14051BP TC74HC138AP</p>	<p>AN7337</p>	<p>LC7522</p>	<p>HD614042SJ14</p>
<p>AN78N05</p>	<p>2SB621AQRSTA</p>	<p>2SA1309AQSTA 2SC3311AQSTA</p>	<p>2SB1357DEFTA 2SD2037DEFTA</p>	<p>DTA114ESTP DTA114TSTP DTC143TSTP</p>	<p>MA165TA 1SS291TA 1SR35200TB</p>
<p>MA4110MTA MA4150MTA MA4270MTA</p>	<p>MA4051MTA MA4068MTA</p>				

WIRING CONNECTION DIAGRAM

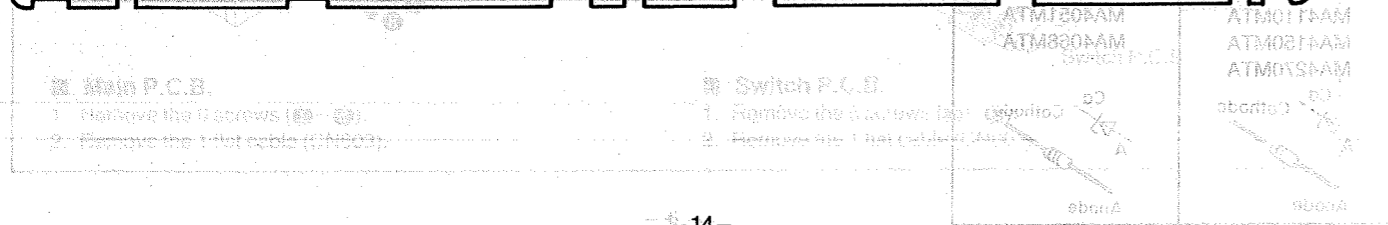
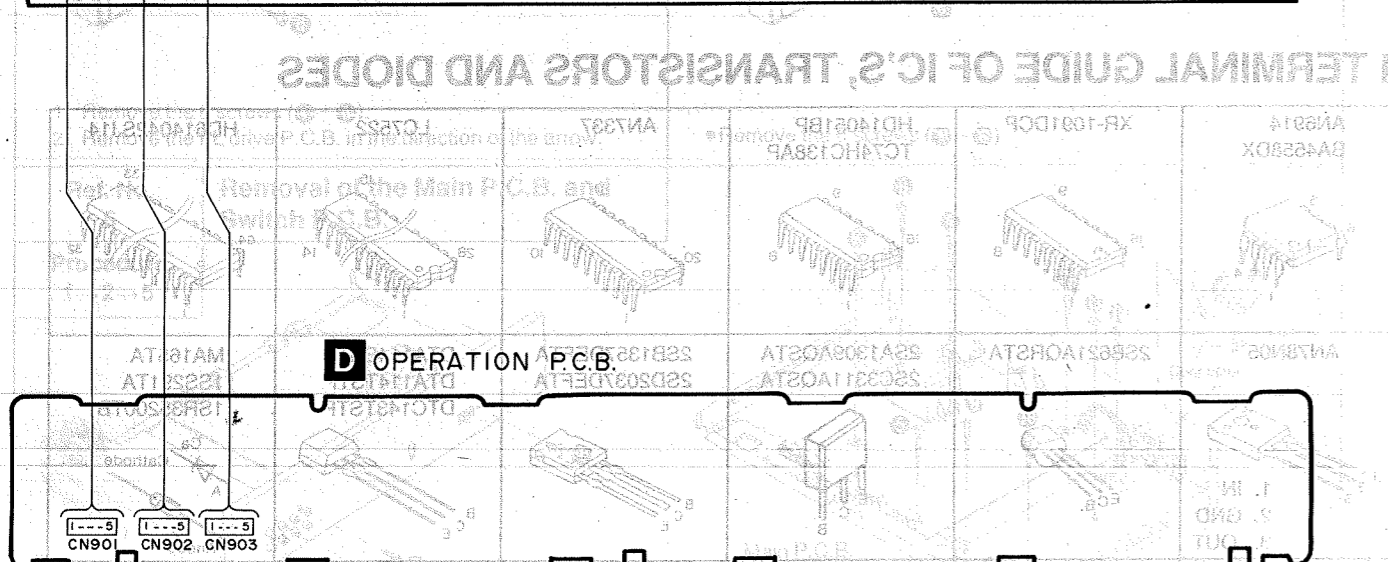
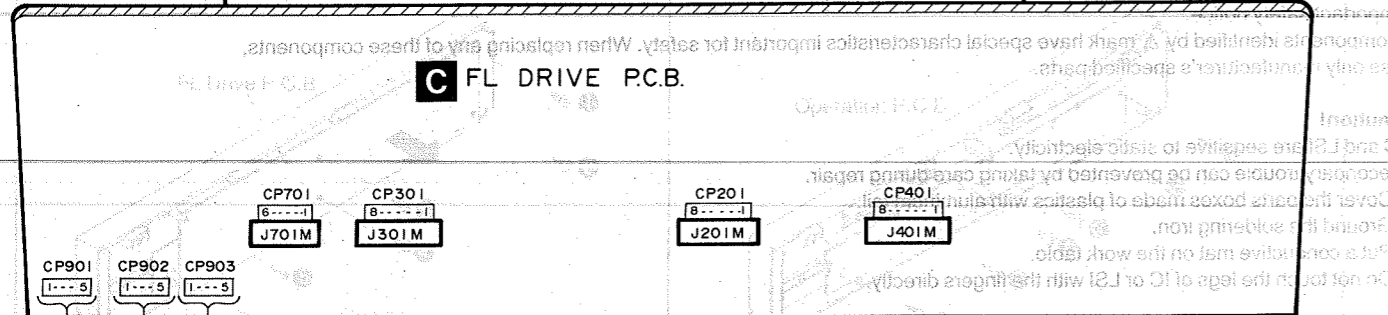
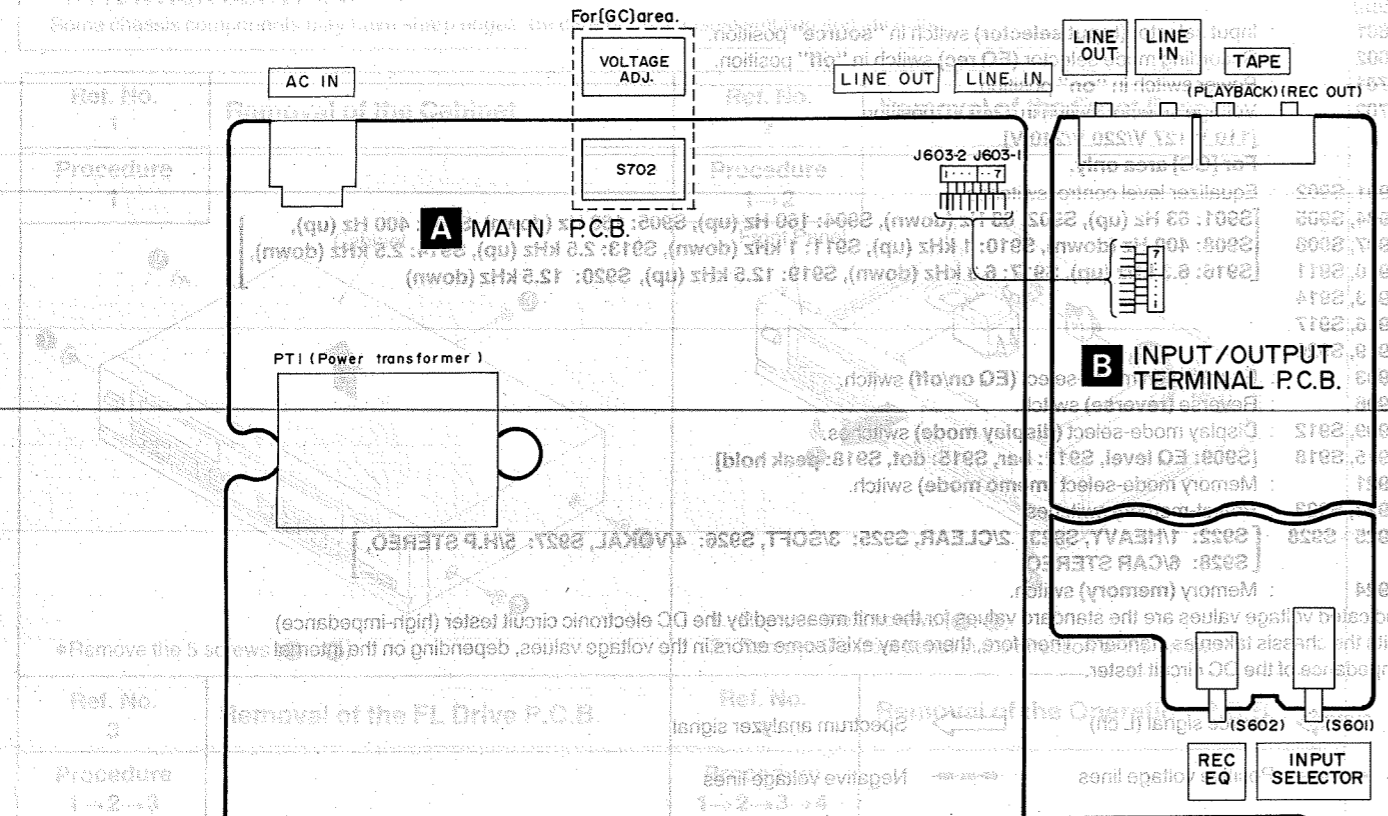

PRINTED CIRCUIT BOARDS (Parts list: pages 20~22; Terminal guide: page 13)

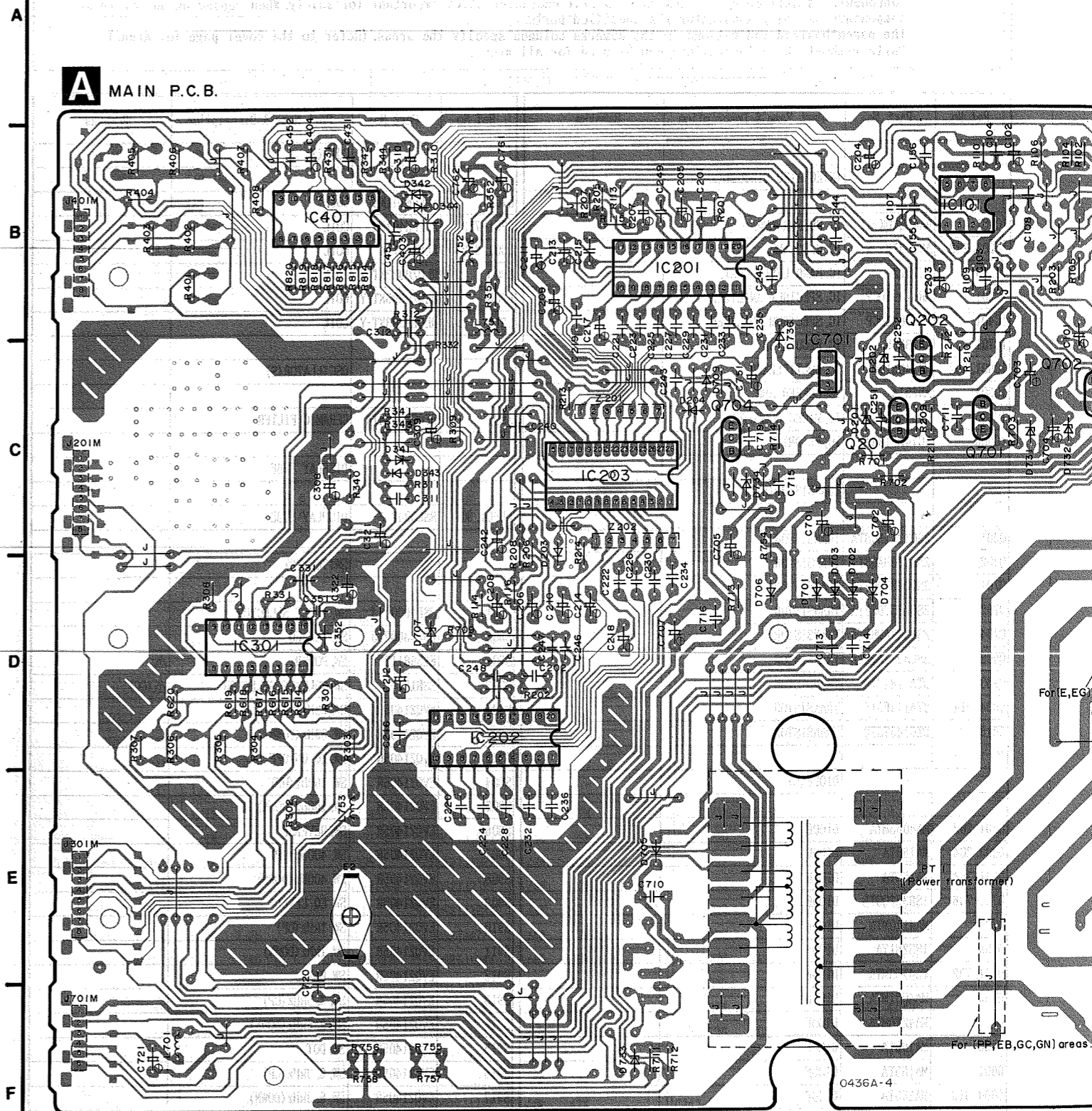

5 6 7 8 9 10 11 12 13 14

B INPUT/OUTPUT TERMINAL P.C.B.

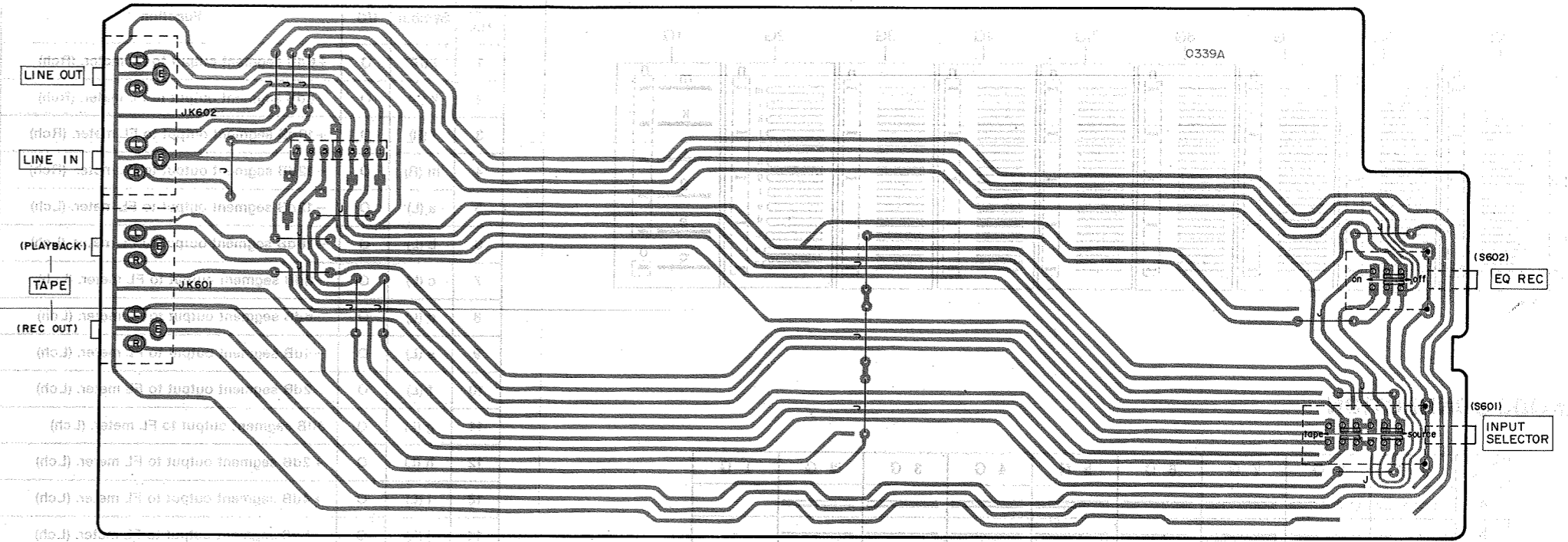

C FL DRIVE P.C.B.

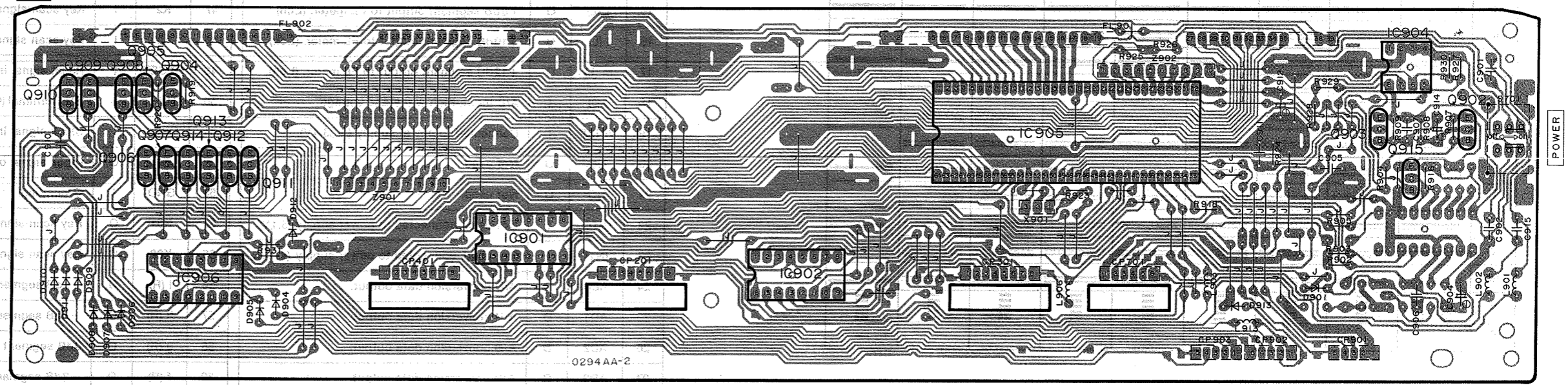

D OPERATION P.C.B.

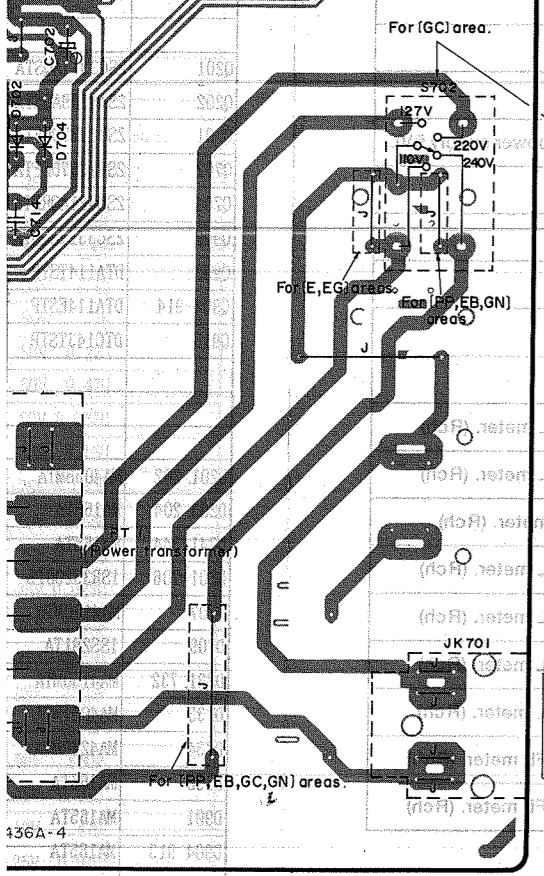
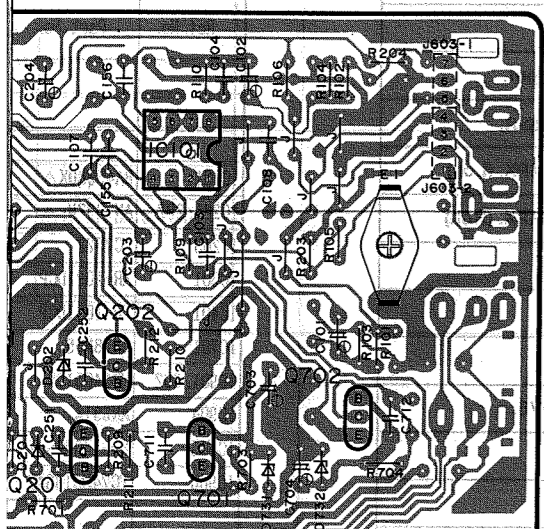
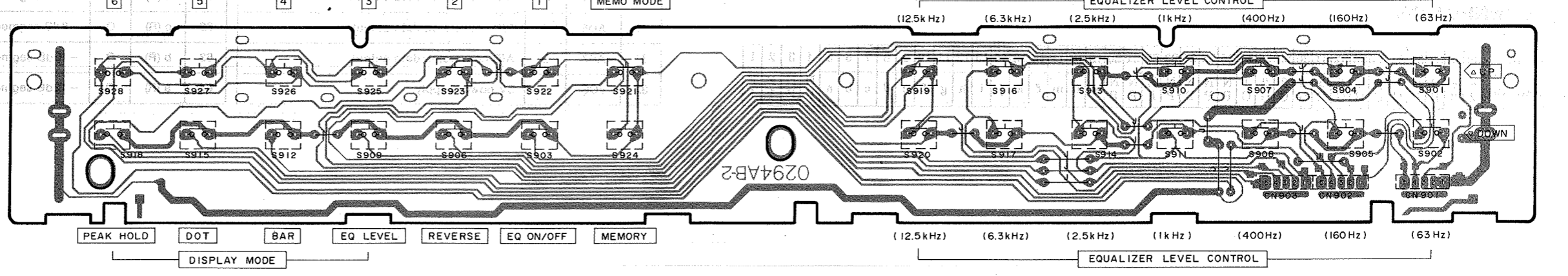

DESCRIPTION OF FL PANEL [FL901, 902 (RSL0042-F)]

GRID ASSIGNMENT

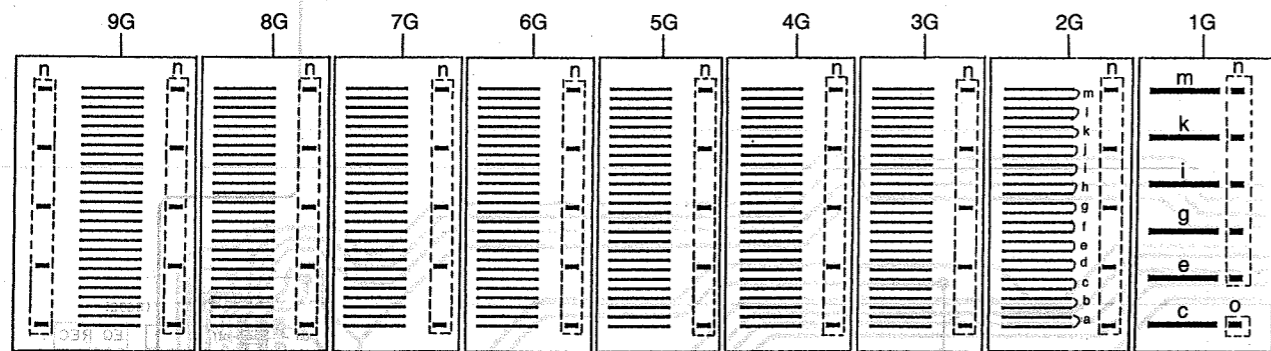

ANODE CONNECTION

	9 G	8 G	7 G	6 G	5 G	4 G	3 G	2 G	1 G
a	=====	=====	=====	=====	=====	=====	=====	=====	-
b	=====	=====	=====	=====	=====	=====	=====	=====	-
c	=====	=====	=====	=====	=====	=====	=====	=====	=====
d	=====	=====	=====	=====	=====	=====	=====	=====	-
e	=====	=====	=====	=====	=====	=====	=====	=====	=====
f	=====	=====	=====	=====	=====	=====	=====	=====	-
g	=====	=====	=====	=====	=====	=====	=====	=====	=====
h	=====	=====	=====	=====	=====	=====	=====	=====	-
i	=====	=====	=====	=====	=====	=====	=====	=====	=====
j	=====	=====	=====	=====	=====	=====	=====	=====	-
k	=====	=====	=====	=====	=====	=====	=====	=====	=====
l	=====	=====	=====	=====	=====	=====	=====	=====	-
m	=====	=====	=====	=====	=====	=====	=====	=====	=====
n	=====	=====	=====	=====	=====	=====	=====	=====	=====
o	-	-	-	-	-	-	-	-	=====

PIN CONNECTION

PIN NO.	39	38	37	36	35	34	33	32	31	30	29	28	27	26	25	24	23	22	21	20	19	18	17	16	15	14	13	12	11	10	9	8	7	6	5	4	3	2	1		
CONNECTION	F2	E2	N	N	P	9	8	7	6	5	4	3	2	1	N	N	N	N	N	N	o	n	m	l	k	j	i	h	g	f	e	d	c	b	a	N	N	F	F	1	1

FUNCTIONS OF IC TERMINALS

IC905 (HD614042SJ14): Microcomputer

Pin No.	Symbol	I/O	Function
1	j (R)	O	+6dB segment output to FL meter. (Rch)
2	k (R)	O	+8dB segment output to FL meter. (Rch)
3	l (R)	O	+10dB segment output to FL meter. (Rch)
4	m (R)	O	+12dB segment output to FL meter. (Rch)
5	a (L)	O	-12dB segment output to FL meter. (Lch)
6	b (L)	O	-10dB segment output to FL meter. (Lch)
7	c (L)	O	-8dB segment output to FL meter. (Lch)
8	d (L)	O	-6dB segment output to FL meter. (Lch)
9	e (L)	O	-4dB segment output to FL meter. (Lch)
10	f (L)	O	-2dB segment output to FL meter. (Lch)
11	g (L)	O	0dB segment output to FL meter. (Lch)
12	h (L)	O	+2dB segment output to FL meter. (Lch)
13	i (L)	O	+4dB segment output to FL meter. (Lch)
14	j (L)	O	+6dB segment output to FL meter. (Lch)
15	k (L)	O	+8dB segment output to FL meter. (Lch)
16	l (L)	O	+10dB segment output to FL meter. (Lch)
17	m (L)	O	+12dB segment output to FL meter. (Lch)
18	ADI	I	A/D input, high withstand voltage.
19	VDISP	I	Connected to power supply (-33.4V).
20	NC	O	Not used.
21	NC	O	Not used.
22	INTO	I	Not used, connected to power supply (5.1V).
23	INTI	I	Not used, connected to power supply (4.4V).
24	AD0	O	A/D conversion data output.
25	AD1	O	A/D conversion data output.
26	AD2	O	A/D conversion data output.
27	AD3	O	A/D conversion data output.
28	AD4	O	A/D conversion data output.
29	AD5	O	A/D conversion data output.
30	AD6	O	A/D conversion data output.
31	AD7	O	A/D conversion data output.
32	VCC	I	5V power supply.

Pin No.	Symbol	I/O	Function
33	SCK	I	Remote control data. Communication data clock input.
34	SD	I	Remote control data. Communication data input.
35	MUT1	O	Not used, connected to power supply (+4.8V).
36	MUT2	O	Muting output.
37	VOLD	O	Data signal of Band Level output.
38	VOLC	O	Clock signal of Band level output.
39	CS (L)	O	Inhibit data signal output to MPX. (Lch)
40	CS (R)	O	Inhibit data signal output to MPX. (Rch)
41	A	O	MPX data output.
42	B	O	MPX data output.
43	C	O	MPX data output.
44	CS	O	Data signal output to FL DRIVE.
45	NC	I	Not used, open.
46	K3	I	Key scan signal input.
47	K2	I	Key scan signal input.
48	K1	I	Key scan signal input.
49	RESET	I	Reset signal input.
50	TEST	-	Test terminal (Connected to power supply 5V).
51	OSC1	I	Clock signal input.
52	OSC2	O	Clock signal output.
53	GND	I	Grounding.
54	K01	O	Key scan signal output.
55	K02	O	Key scan signal output.
56	i (R)	O	+4dB segment output to FL meter. (Rch)
57	h (R)	O	+2dB segment output to FL meter. (Rch)
58	g (R)	O	0dB segment output to FL meter. (Rch)
59	f (R)	O	-2dB segment output to FL meter. (Rch)
60	e (R)	O	-4dB segment output to FL meter. (Rch)
61	d (R)	O	-6dB segment output to FL meter. (Rch)
62	c (R)	O	-8dB segment output to FL meter. (Rch)
63	b (R)	O	-10dB segment output to FL meter. (Rch)
64	a (R)	O	-12dB segment output to FL meter. (Rch)

REPLACEMENT PARTS

Notes : * Impor
Comp
comp
* The p
Parts

Ref. No.	Part No.
IC101	BA4558DX
IC201, 202	AN7337N
IC203	LC7522
IC301	XR-1091DCP
IC401	XR-1091DCP
IC701	AN78N05
IC901, 902	HD14051BP
IC904	AN6914
IC905	HD614042SJ
IC906	TC74HC138A
Q201	2SC3311AQS
Q202	2SA1309AQS
Q701	2SD2037DEF
Q702	2SB1357DEF
Q704	2SB621AQRS
Q902	2SC3311AQS
Q903	DTA114TSTP
Q904-914	DTA114ESTP
Q915	DTC143TSTP
D201, 202	MA4068MTA
D203, 204	MA165TA
D341-344	MA165TA
D701-706	1SR35200TB
D707	MA4110MTA
D709	1SS291TA
D731, 732	MA4150MTA
D733	MA4051MTA
D734	MA4270MTA
D736	MA165TA
D901	MA165TA
D904-913	MA165TA
Z201, 202	EXBF7E224JY
Z901	EXBF10E104J
Z902	EXBF10L795J

REPLACEMENT PARTS LIST

Notes : * Important safety notice:
 Components identified by Δ mark have special characteristics important for safety. When replacing any of these components use only manufacturer's specified parts.
 * The parenthesized indications in the Remarks columns specify the areas. (Refer to the cover page for area.)
 Parts without these indications can be used for all areas.

Ref. No.	Part No.	Part Name & Description	Remarks	Ref. No.	Part No.	Part Name & Description	Remarks
		INTEGRATED CIRCUIT (S)				COIL (S)	
IC101	BA4558DX	IC, BUFFER AMP.		L701	ELEPK101KA	COIL	
IC201, 202	AN7337N	IC, G. EQ. AMP.		L751-753	ELEPK4R7KA	COIL	
IC203	LC7522	IC, BAND LEVEL CONT.		L901, 902	ELEV4R7KA	COIL	
IC301	XR-109IDCP	IC, SPECTRUM ANALYZER		L903	RLQZP3R3KT-Y	COIL	
IC401	XR-109IDCP	IC, SPECTRUM ANALYZER		L906	RLQZP3R3KT-Y	COIL	
IC701	AN78N05	IC, REGULATOR		L913	RLQZP3R3KT-Y	COIL	
IC901, 902	HD14051BP	IC, MULTIPLEXER				OSCILLATOR (S)	
IC904	AN6914	IC, BUFFER AMP.					
IC905	HD614042SJ14	IC, MICRO COMPUTER		X901	EFOGC4004T4	CERAMIC FILTER	
IC906	TC74HC138AP	IC, FL DRIVE				DISPLAY TUBE	
		TRANSISTOR (S)				DISPLAY TUBE	
Q201	2SC3311AQSTA	TRANSISTOR		FL901, 902	RSL0042-F	DISPLAY TUBE	
Q202	2SA1309AQSTA	TRANSISTOR				SWITCH (ES)	
Q701	2SD2037DEFTA	TRANSISTOR		S601	RSP3D001-J	SW, INPUT SELECTOR	
Q702	2SB1357DEFTA	TRANSISTOR		S602	RSP3B002-J	SW, REC. EQ.	
Q704	2SB621AQRSTA	TRANSISTOR		S701	ESB68113	SW, POWER	Δ
Q902	2SC3311AQSTA	TRANSISTOR		S702	SSR187-1	SW, VOLTAGE SELECTOR	Δ (GC)
Q903	DTA114TSTP	TRANSISTOR		S901	EVQ21405R	SW, 63Hz (UP)	
Q904-914	DTA114ESTP	TRANSISTOR		S902	EVQ21405R	SW, 63Hz (DOWN)	
Q915	DTC143TSTP	TRANSISTOR		S903	EVQ21405R	SW, EQ ON/OFF	
		DIODE (S)		S904	EVQ21405R	SW, 160Hz (UP)	
D201, 202	MA4068MTA	DIODE		S905	EVQ21405R	SW, 160Hz (DOWN)	
D203, 204	MA165TA	DIODE		S906	EVQ21405R	SW, REVERSE	
D341-344	MA165TA	DIODE		S907	EVQ21405R	SW, 400Hz (UP)	
D701-706	1SR35200TB	DIODE	Δ	S908	EVQ21405R	SW, 400Hz (DOWN)	
D707	MA4110MTA	DIODE		S909	EVQ21405R	SW, EQ LEVEL	
D709	ISS291TA	DIODE		S910	EVQ21405R	SW, 1kHz (UP)	
D731, 732	MA4150MTA	DIODE		S911	EVQ21405R	SW, 1kHz (DOWN)	
D733	MA4051MTA	DIODE		S912	EVQ21405R	SW, BAR	
D734	MA4270MTA	DIODE		S913	EVQ21405R	SW, 2.5kHz (UP)	
D736	MA165TA	DIODE		S914	EVQ21405R	SW, 2.5kHz (DOWN)	
D901	MA165TA	DIODE		S915	EVQ21405R	SW, DOT	
D904-913	MA165TA	DIODE		S916	EVQ21405R	SW, 6.3kHz (UP)	
		COMPONENT COMBINATION (S)		S917	EVQ21405R	SW, 6.3kHz (DOWN)	
Z201, 202	EXBF7E224JYV	COMPONENT COMBINATION		S918	EVQ21405R	SW, PEAK HOLD	
Z901	EXBF10E104J	COMPONENT COMBINATION		S919	EVQ21405R	SW, 12.5kHz (UP)	
Z902	EXBF10L795J	COMPONENT COMBINATION		S920	EVQ21405R	SW, 12.5kHz (DOWN)	
				S921	EVQ21405R	SW, MEMORY MODE	
				S922	EVQ21405R	SW, PRESET (1)	
				S923	EVQ21405R	SW, PRESET (2)	
				S924	EVQ21405R	SW, MEMORY	

Ref. No.	Part No.	Part Name & Description	Remarks	Ref. No.	Part No.	Part Name & Description	Remarks
S925	EVQ21405R	SW, PRESET (3)		J401M	RJU003K008M1	SOCKET (8P)	
S926	EVQ21405R	SW, PRESET (4)		J701M	RJU003K006M1	SOCKET (6P)	
S927	EVQ21405R	SW, PRESET (5)		CN901-903	SJS50581BB	SOCKET (5P)	
S928	EVQ21405R	SW, PRESET (6)		CP201	RJT003K008M1	CONNECTOR (8P)	
		JACK (S)		CP301	RJT003K008M1	CONNECTOR (8P)	
				CP401	RJT003K008M1	CONNECTOR (8P)	
				CP701	RJT003K006M1	CONNECTOR (6P)	
				CP901-903	SJT305498B1	CONNECTOR (5P)	
JK601	SJF3069N	TERMINAL (TAPE IN/OUT)				TRANSFORMER	
JK602	SJF3069N	TERMINAL (LINE IN/OUT)					
JK701	SJSD16	AC INLET	Δ (PP/GN)				
JK701	SJS9236	AC INLET	Δ (E, EB, EG, GC)				
J603-1	RJS1A1703	CONNECTOR (3P)		PT1	RTP1K4C006	POWER TRANSFORMER	Δ (PP)
J603-2	RJS1A1704	CONNECTOR (4P)		PT1	RTP1K4E010	POWER TRANSFORMER	Δ (E, EB, EG, GC, GN)
J201M	RJU003K008M1	SOCKET (8P)					
J301M	RJU003K008M1	SOCKET (8P)					

Notes : * Capacity value are in microfarads (μ F) unless specified otherwise, P=Pico-farads (pF) F=Farads (F) *
 * Resistance values are in ohms, unless specified otherwise, 1K=1,000 (OHM) , 1M=1,000k (OHM)

Ref. No.	Part No.	Values & Remarks	Ref. No.	Part No.	Values & Remarks	Ref. No.	Part No.	Values & Remarks
		RESISTORS	R701, 702	ERD2FCVJ4R7T	1/4W 4.7 Δ	C107, 108	ECBT1E1032F5	25V 0.01U
			R703, 704	ERDS2TJ152T	1/4W 1.5K	C155, 156	ECBT1H102KB5	50V 1000P
			R709	ERDS2TJ273T	1/4W 27K	C201, 202	ECBT1H121KB5	50V 120P
R101, 102	ERDS2TJ102T	1/4W 1K	R711, 712	ERD25FVJ101T	1/4W 100 Δ	C203-208	ECEA1EK3R3B	25V 3.3U
R103, 104	ERDS2TJ104T	1/4W 100K	R713	ERDS2TJ103T	1/4W 10K	C209, 210	ECEA1HK010B	50V 1U
R105, 106	ERDS2TJ102T	1/4W 1K	R714	ERDS2TJ102T	1/4W 1K	C211, 212	ECEA1HKR22B	50V 0.22U
R109, 110	ERDS2TJ104T	1/4W 100K	R754	ERD2FCVG470T	1/4W 47 Δ	C213, 214	ECEA1HKR47B	50V 0.47U
R113, 114	ERDS2TJ153T	1/4W 15K	R755-758	ERDS1FVJ150T	1/2W 15 Δ	C215, 216	ECQV1H823JZ3	50V 0.082U
R115, 116	ERDS2TJ223T	1/4W 22K	R814-820	ERDS2TJ122T	1/4W 1.2K	C217, 218	ECEA1HKR15B	50V 0.15U
R201, 202	ERDS2TJ153T	1/4W 15K	R902-904	ERDS2TJ103T	1/4W 10K	C219, 220	ECFR1E333KR	25V 0.033U
R203, 204	ERDS2TJ104T	1/4W 100K	R905	ERDS2TJ102T	1/4W 1K	C221, 222	ECQV1H683JZ3	50V 0.68U
R205, 206	ERDS2TJ123T	1/4W 12K	R907-909	ERDS2TJ332T	1/4W 3.3K	C223, 224	ECFR1E153KR	25V 0.015U
R207, 208	ERDS2TJ224T	1/4W 220K	R916	ERDS2TJ222T	1/4W 2.2K	C225, 226	ECFR1E273KR	25V 0.027U
R209, 210	ERDS2TJ222T	1/4W 2.2K	R918	ERDS2TJ472T	1/4W 4.7K	C227, 228	ECFR1E562KR	25V 5600P
R211, 212	ERDS1FVJ181T	1/2W 180 Δ	R919, 920	ERDS2TJ104T	1/4W 100K	C229, 230	ECFR1E103KR	25V 0.01U
R213, 214	ERDS2TJ224T	1/4W 220K	R923	ERDS2TJ684T	1/4W 680K	C231, 232	ECFR1E222KR	25V 2200P
R301-308	ERDS2TJ104T	1/4W 100K	R924, 925	ERDS2TJ104T	1/4W 100K	C233, 234	ECFR1E472KR	25V 4700P
R309, 310	ERDS2TJ472T	1/4W 4.7K	R926	ERDS2TJ103T	1/4W 10K	C235, 236	ECKR1H681KB5	50V 680P
R311, 312	ERDS2TJ123T	1/4W 12K	R927	ERDS2TJ104T	1/4W 100K	C240	ECBT1E1032F5	25V 0.01U
R331	ERDS2TJ152T	1/4W 1.5K	R928	ERDS2TJ103T	1/4W 10K	C242	ECEA1AK470B	10V 47U
R332	ERDS2TJ103T	1/4W 10K	R929	ERDS2TJ473T	1/4W 47K	C243-247	ECBT1E1032F5	25V 0.01U
R340	ERDS2TJ471T	1/4W 470	R930	ERDS2TJ104T	1/4W 100K	C248, 249	ECBT1H101KB5	50V 100P
R341, 342	ERDS2TJ823T	1/4W 82K	R931	ERDS2TJ103T	1/4W 10K	C251, 252	ECBT1E1032F5	25V 0.01U
R343, 344	ERDS2TJ561T	1/4W 560				C308	ECEA1CK100B	16V 10U
R351, 352	ERDS2TJ220T	1/4W 22				C309, 310	ECEA1EK3R3B	25V 3.3U
R401-408	ERDS2TJ104T	1/4W 100K				C311, 312	ECBT1H101KB5	50V 100P
R431	ERDS2TJ182T	1/4W 1.8K				C321, 322	ECEA1AK330B	10V 33U
R614-620	ERDS2TJ122T	1/4W 1.2K	C101, 102	ECEA1EK3R3B	25V 3.3U	C331	ECQM1H102KV3	50V 1000P
			C103, 104	ECBT1H101KB5	50V 100P			

Ref. No.	Part No.	Values & Remarks	Ref. No.	Part No.	Values & Remarks	Ref. No.	Part No.	Values & Remarks
C351, 352	ECBT1H102KB5	50V 1000P	C711, 712	ECKR1H103ZF5	50V 0.01U	C904	ECEAOJK470B	6.3V 47U
C403, 404	ECEA1AK330B	10V 33U	C713-716	ECKR1H223ZF5	50V 0.022U	C905	ECKR1H223ZF5	50V 0.022U
C431	ECQM1H102KV3	50V 1000P	C719	ECKR1H103ZF5	50V 0.01U	C906	ECKR1H103ZF5	50V 0.01U
C451, 452	ECBT1H102KB5	50V 1000P	C720	ECKR1H102ZF5	50V 1000P	C907	ECKR1H223ZF5	50V 0.022U
C701, 702	ECEA1VU221B	35V 220U	C721	ECEAOJK101B	6.3V 100U	C910	ECKR1H102KB5	50V 1000P
C703, 704	ECEA1CU101B	16V 100U	C751	ECEAOJU102B	6.3V 1000U	C911	ECKR1H223ZF5	50V 0.022U
C705	ECEA1HU221B	50V 220U	C761	ECEA1AK221B	10V 220U	C912	ECEAOJU471B	6.3V 470U
C707	ECEA1CK100B	16V 10U	C762	ECEA1CK100B	16V 10U	C914	ECEA1EK4R7B	25V 4.7U
C710	ECKR1H223ZF5	50V 0.022U	C901, 902	ECKR1H103ZF5	50V 0.01U	C915	ECKR1H102KB5	50V 1000P

Ref. No.	Part No.	Part Name & Description	Remarks	Ref. No.	Part No.	Part Name & Description	Remarks
CABINET PARTS				ACCESSORIES			
1	RRM0114-K	CABINET		A1	RQF0641	INSTRUCTIONS MANUAL ASS'Y (PP)	
2	SNE2129-1	SCREW		A1	RQF0642	INSTRUCTIONS MANUAL ASS'Y (E)	
3	XTBS3+8JFZ1	SCREW		A1	RQF0643	INSTRUCTIONS MANUAL ASS'Y (EB)	
4	RGR0082B-A	REAR PANEL (PP)		A1	RQF0644	INSTRUCTIONS MANUAL ASS'Y (EG)	
4	RGR0082B-B	REAR PANEL (E)		A1	RQF0645	INSTRUCTIONS MANUAL ASS'Y (GC)	
4	RGR0082B-C	REAR PANEL (EB/GN)		A1	RQF0646	INSTRUCTIONS MANUAL ASS'Y (GN)	
4	RGR0082B-D	REAR PANEL (EG)		A1-1	RQT0524-P	INSTRUCTIONS MANUAL (PP)	
4	RGR0082C-A	REAR PANEL (GC)		A1-1	RFKSHGE70E-K	INSTRUCTIONS MANUAL (E)	
5	RFKJT610LE-K	CHASSIS ASS'Y		A1-1	RQT0527-B	INSTRUCTIONS MANUAL (EB, GN)	
5-1	RKA0009-1	FOOT		A1-1	RQT0528-D	INSTRUCTIONS MANUAL (EG)	
6	RFKSHGE70PPK	FRONT PANEL ASS'Y (PP)		A1-1	RQT0525-G	INSTRUCTIONS MANUAL (GC)	
6	RFKSHGE70E-K	FRONT PANEL (E, EB, EG, GC, GN)		A1-2	SQX7179	WARRANTY CARD (PP)	
7	RGU0030	POWER BUTTON		A1-2	RQA0013	WARRANTY CARD (E, EB, EG)	
8	RGU0359A-K1	EQ BUTTON (L)		A1-2	SQX7186	WARRANTY CARD (GN)	
9	RGU0359B-K1	EQ BUTTON (R)		A1-3	SQX9129-1	SERVICENTOR LIST (PP)	
10	XTBS26+10J	SCREW		A1-3	RQCB0169	SERVICENTOR LIST (E, EB, EG, GC, GN)	
11	SHE187-2	HOLDER		A1-4	RQA0049	WARRANTY CARD for CANADA (PP)	
12	XTBS3+22F	SCREW		A1-5	SQX9131	SERVICENTOR LIST for CANADA (PP)	
13	XTB3+20JFZ	SCREW		A1-6	RQCS0009	CAUTION NOTE for FTZ (EG)	
14	RMN0043	FL HOLDER (L-R)		A2	SJA175	POWER CORD Δ (PP)	
15	RMN0071	FL HOLDER		A2	SFDAC05E03	POWER CORD Δ (E, EG)	
16	RGU0163	EQ REC BUTTON		A2	SJA193	POWER CORD Δ (EB)	
PACKING MATERIALS				A2	RJA0004	POWER CORD Δ (GC)	
P1	RPG0500	CARTON BOX		A2	SJA173	POWER CORD Δ (GN)	
P2	RPN0326	PAD		A3	SJP2249-3	PIN CORD	
P3	XZB52X60A01Z	PROTECTION COVER		A4	SJP9215	ATTACHMENT PLUG Δ (GC)	
P4	SPSD152	ACCESSORIES BOX					

EXPLODED VIEW

